

SKIL®

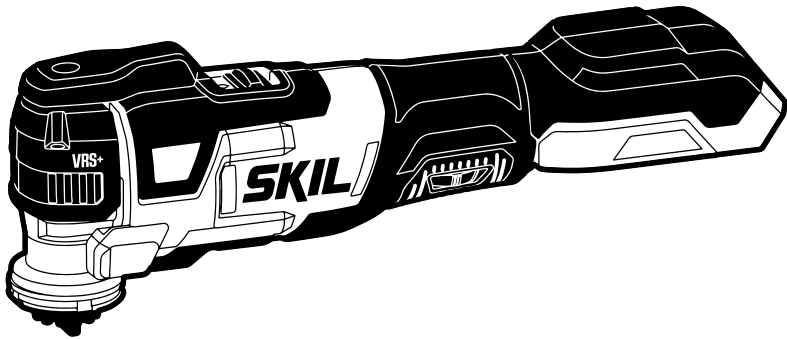

Model: OS5937E-00

PWRCORE 20™

Brushless Multi Tool

⚠ WARNING: To reduce the risk of injury, the user must read and understand the Owner's Manual before using this product. Save these instructions for future reference.



For Customer Service

1300-017-545 OR **www.skil.com.au**

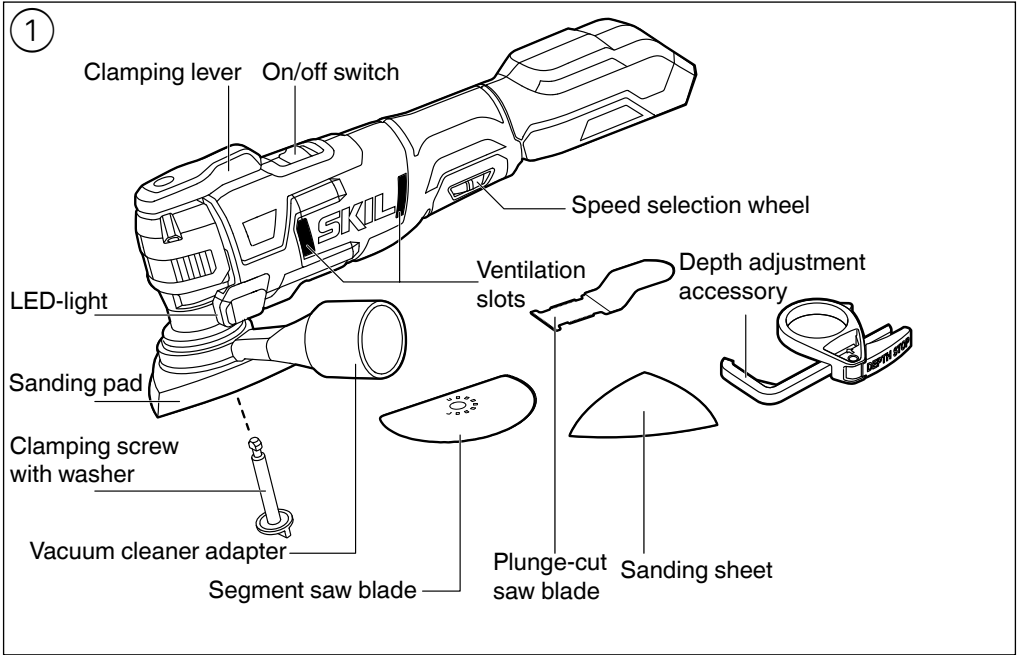

② **SPECIFICATIONS**

Rated Voltage	20V max d.c.
Max Oscillation Rate	11000~17000 /min
Oscillation Angle	±1.8°

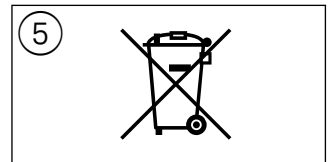
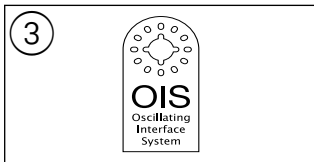

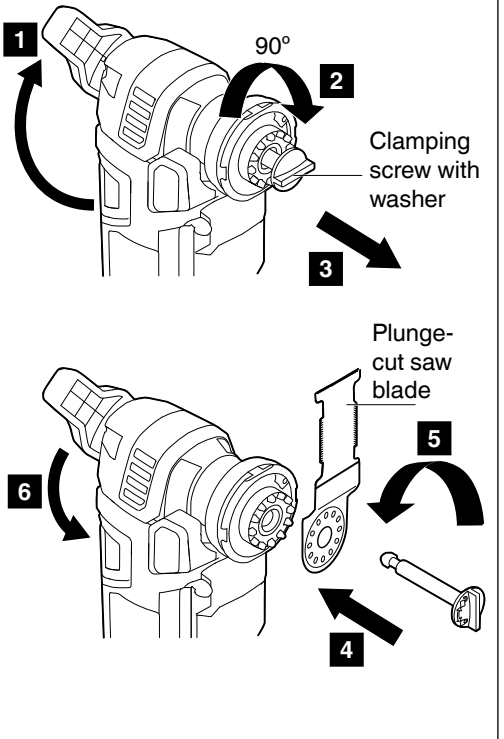
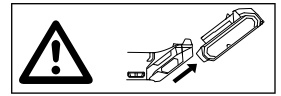
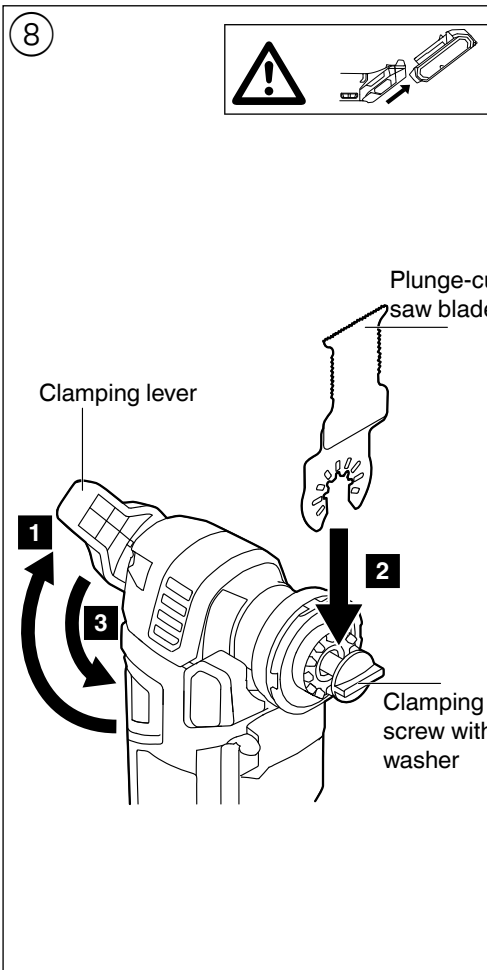
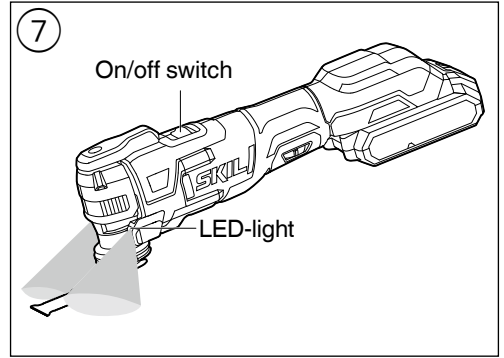
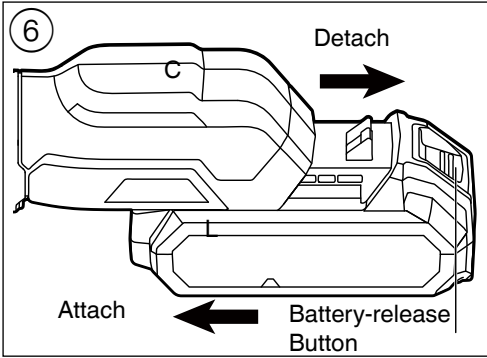

9

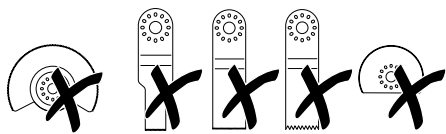

Clamping lever

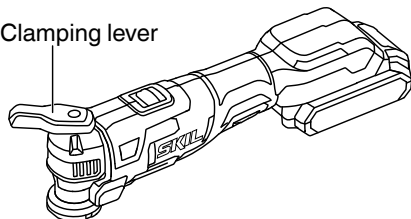

Sanding pad

1



Clamping screw with washer

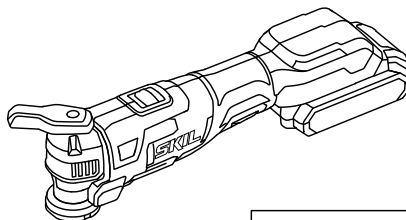

2



3

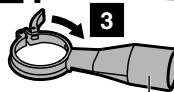

Vacuum cleaner adapter

2

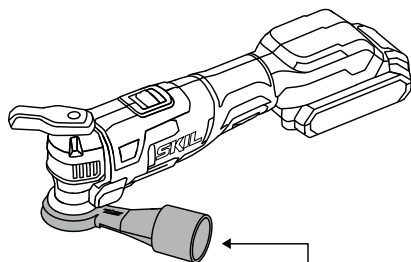
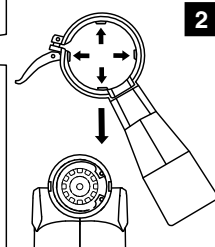

Ø 34-35mm

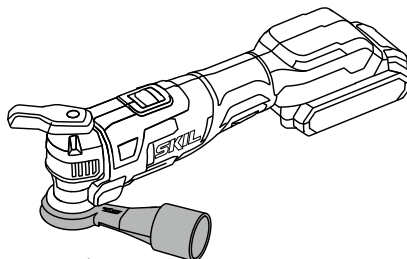
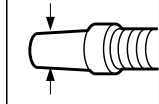

Sanding pad

4



Clamping screw with washer

10

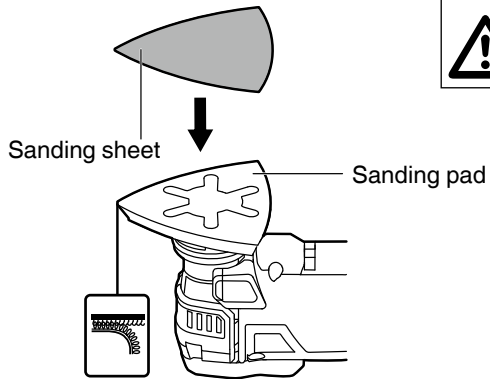

11

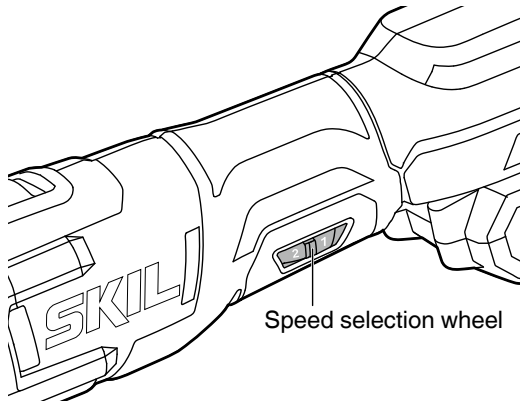

12

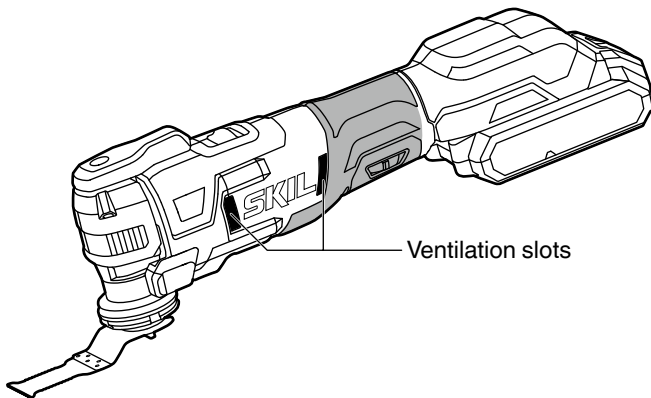



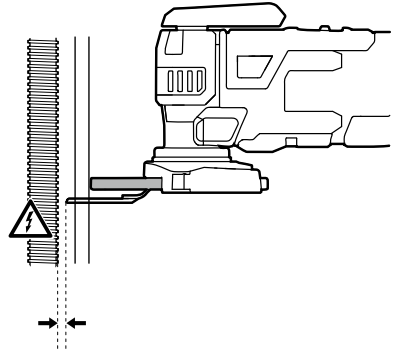
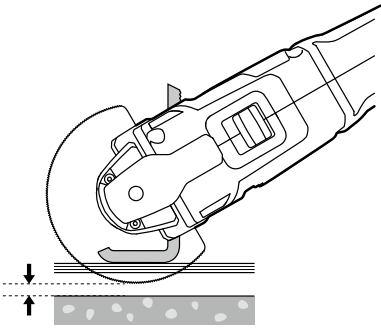



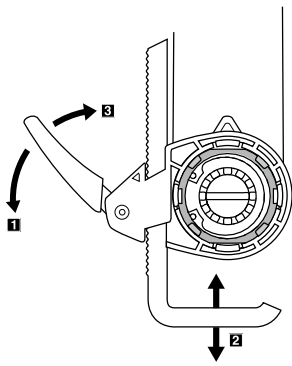
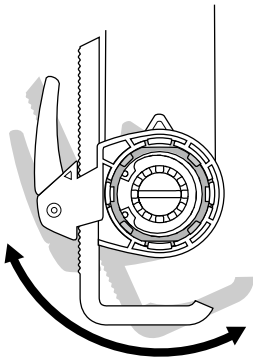
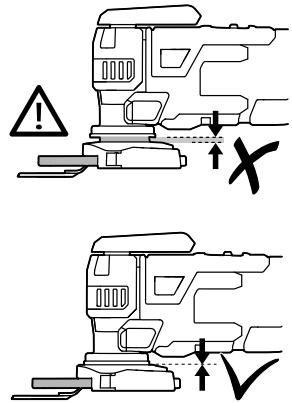
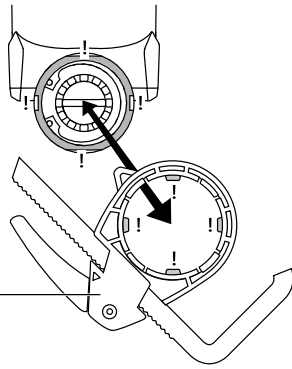

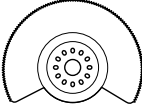
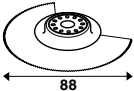
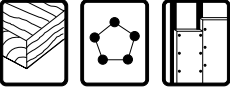
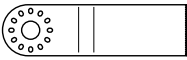

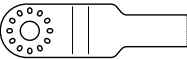

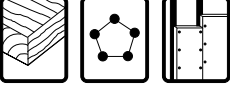

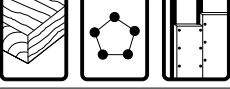
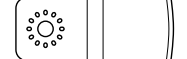
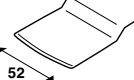





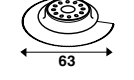

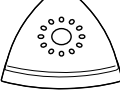
13

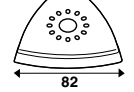

Depth adjustment accessory



<p>14</p> 	 <p>88</p>	
	 <p>32 40</p>	
<p>*</p> 	 <p>20 40</p>	
<p>*</p> 	 <p>32 40</p>	
<p>*</p> 	 <p>52</p>	
<p>*</p> 	 <p>52</p>	
<p>*</p> 	 <p>63</p>	 <p>EPOXY</p>
 	 <p>82</p> <div style="display: flex; flex-direction: column; align-items: center;"> <div style="border: 1px solid black; padding: 5px; margin-bottom: 5px;"> <p>60</p>  </div> <div style="border: 1px solid black; padding: 5px; margin-bottom: 5px;"> <p>80</p>  </div> <div style="border: 1px solid black; padding: 5px; margin-bottom: 5px;"> <p>120</p>  </div> <div style="border: 1px solid black; padding: 5px;"> <p>180</p>  </div> </div> <p>*</p>	

* NOT INCLUDED AS A STANDARD ACCESSORY

INTRODUCTION

- This tool is intended for sawing and cutting in wood, plastic, plaster, metals and soft wall tiles as well as for dry sanding and scraping of small surfaces
- It is especially suitable for working close to edges, for plunge cutting and for flush cutting
- This tool is not intended for professional use
- This tool accepts most commonly available multi-tool accessories, including existing OIS and Starlock accessories ③
- Read and save this instruction manual ④

* NOT STANDARD INCLUDED

SAFETY

GENERAL POWER TOOL SAFETY WARNINGS

⚠ WARNING Read all safety warnings, instructions, illustrations and specifications provided with this power tool. Failure to follow all instructions listed below may result in electric shock, fire and/or serious injury.

Save all warnings and instructions for future reference.

The term "power tool" in the warnings refers to your mains-operated (corded) power tool or battery-operated (cordless) power tool.

1) WORK AREA SAFETY

- a) **Keep work area clean and well lit.** Cluttered or dark areas invite accidents.
- b) **Do not operate power tools in explosive atmospheres, such as in the presence of flammable liquids, gases or dust.** Power tools create sparks which may ignite the dust or fumes.
- c) **Keep children and bystanders away while operating a power tool.** Distractions can cause you to lose control.

2) ELECTRICAL SAFETY

- a) **Power tool plugs must match the outlet. Never modify the plug in any way. Do not use any adapter plugs with earthed (grounded) power tools.** Unmodified plugs and matching outlets will reduce risk of electric shock.
- b) **Avoid body contact with earthed or grounded surfaces such as pipes, radiators, ranges and refrigerators.** There is an increased risk of electric shock if your body is earthed or grounded.
- c) **Do not expose power tools to rain or wet conditions.** Water entering a power tool will increase the risk of electric shock.
- d) **Do not abuse the cord. Never use the cord for carrying, pulling or unplugging the power tool. Keep cord away from heat, oil, sharp edges or moving parts.** Damaged or entangled cords increase the risk of electric shock.
- e) **When operating a power tool outdoors, use an extension cord suitable for outdoor use.** Use of a cord suitable for outdoor use reduces the risk of electric shock.
- f) **If operating a power tool in a damp location is unavoidable, use a residual current device (RCD) protected supply.** Use of an RCD reduces the risk of electric shock.

3) PERSONAL SAFETY

- a) **Stay alert, watch what you are doing and use common sense when operating a power tool. Do not use a power tool while you are tired or under the influence of drugs, alcohol or medication.** A moment of inattention while operating power tools may result in serious personal injury.
 - b) **Use personal protective equipment. Always wear eye protection.** Protective equipment such as a dust mask, non-skid safety shoes, hard hat, or hearing protection used for appropriate conditions will reduce personal injuries.
 - c) **Prevent unintentional starting. Ensure the switch is in the off-position before connecting to power source and/or battery pack, picking up or carrying the tool.** Carrying power tools with your finger on the switch or energising power tools that have the switch on invites accidents.
 - d) **Remove any adjusting key or wrench before turning the power tool on.** A wrench or a key left attached to a rotating part of the power tool may result in personal injury.
 - e) **Do not overreach. Keep proper footing and balance at all times.** This enables better control of the power tool in unexpected situations.
 - f) **Dress properly. Do not wear loose clothing or jewellery. Keep your hair and clothing away from moving parts.** Loose clothes, jewellery or long hair can be caught in moving parts.
 - g) **If devices are provided for the connection of dust extraction and collection facilities, ensure these are connected and properly used.** Use of dust collection can reduce dust-related hazards.
 - h) **Do not let familiarity gained from frequent use of tools allow you to become complacent and ignore tool safety principles.** A careless action can cause severe injury within a fraction of a second.
- #### 4) POWER TOOL USE AND CARE
- a) **Do not force the power tool. Use the correct power tool for your application.** The correct power tool will do the job better and safer at the rate for which it was designed.
 - b) **Do not use the power tool if the switch does not turn it on and off.** Any power tool that cannot be controlled with the switch is dangerous and must be repaired.
 - c) **Disconnect the plug from the power source and/or remove the battery pack, if detachable, from the power tool before making any adjustments, changing accessories, or storing power tools.** Such preventive safety measures reduce the risk of starting the power tool accidentally.
 - d) **Store idle power tools out of the reach of children and do not allow persons unfamiliar with the power tool or these instructions to operate the power tool.** Power tools are dangerous in the hands of untrained users.
 - e) **Maintain power tools and accessories. Check for misalignment or binding of moving parts, breakage of parts and any other condition that may affect the power tool's operation. If damaged, have the power tool repaired before use.** Many accidents are caused by poorly maintained power tools.

- f) **Keep cutting tools sharp and clean.** Properly maintained cutting tools with sharp cutting edges are less likely to bind and are easier to control.
- g) **Use the power tool, accessories and tool bits etc., in accordance with these instructions, taking into account the working conditions and the work to be performed.** Use of the power tool for operations different from those intended could result in a hazardous situation.
- h) **Keep handles and grasping surfaces dry, clean and free from oil and grease.** Slippery handles and grasping surfaces do not allow for safe handling and control of the tool in unexpected situations.
- 5) **BATTERY TOOL USE AND CARE**
- a) **Recharge only with the charger specified by the manufacturer.** A charger that is suitable for one type of battery pack may create a risk of fire when used with another battery pack.
- b) **Use power tools only with specifically designated battery packs.** Use of any other battery packs may create a risk of injury and fire.
- c) **When battery pack is not in use, keep it away from other metal objects like paper clips, coins, keys, nails, screws, or other small metal objects that can make a connection from one terminal to another.** Shorting the battery terminals together may cause burns or a fire.
- d) **Under abusive conditions, liquid may be ejected from the battery; avoid contact. If contact accidentally occurs, flush with water. If liquid contacts eyes, additionally seek medical help.** Liquid ejected from the battery may cause irritation or burns.
- e) **Do not use a battery pack or tool that is damaged or modified.** Damaged or modified batteries may exhibit unpredictable behaviour resulting in fire, explosion or risk of injury.
- f) **Do not expose a battery pack or tool to fire or excessive temperature.** Exposure to fire or temperature above 130°C may cause explosion.
- g) **Follow all charging instructions and do not charge the battery pack or tool outside the temperature range specified in the instructions.** Charging improperly or at temperatures outside the specified range may damage the battery and increase the risk of fire.
- 6) **SERVICE**
- a) **Have your power tool serviced by a qualified repair person using only identical replacement parts.** This will ensure that the safety of the power tool is maintained.
- b) **Never service damaged battery packs.** Service of battery packs should only be performed by the manufacturer or authorized service providers.

SAFETY INSTRUCTIONS FOR CORDLESS MULTI-FUNCTION TOOLS

- **Hold the power tool by insulated gripping surfaces, when performing an operation where the cutting accessory may contact hidden wiring** (cutting accessory contacting a "live" wire may make exposed metal parts of the power tool "live" and could give the operator an electric shock)
- **Use clamps or another practical way to secure and support the workpiece to a stable platform** (holding the workpiece by hand or against your body leaves it unstable and may lead to loss of control)

GENERAL

- This tool should not be used by people under the age of 16 years
- Avoid damage that can be caused by screws, nails and other elements in your workpiece; remove them before you start working
- **Do not work materials containing asbestos** (asbestos is considered carcinogenic)
- Remove battery from tool before making any adjustments or changing accessories
- When working, always hold the tool firmly with both hands and take a secure stance
- Dust from material such as paint containing lead, some wood species, minerals and metal may be harmful (contact with or inhalation of the dust may cause allergic reactions and/or respiratory diseases to the operator or bystanders); **wear a dust mask and work with a dust extraction device when connectable**
- Certain kinds of dust are classified as carcinogenic (such as oak and beech dust) especially in conjunction with additives for wood conditioning; **wear a dust mask and work with a dust extraction device when connectable**
- Follow the dust-related national requirements for the materials you want to work with
- **Use protective gloves when changing accessories** (contact with the accessory can lead to injuries)
- When you put away the tool, switch off the motor and ensure that all moving parts have come to a complete standstill

WHEN SAWING/CUTTING

- **Keep hands away from cutting area;** never reach underneath the material for any reason while cutting
- **Use suitable detectors to find hidden utility lines or call the local utility company for assistance** (contact with electric lines can lead to fire or electrical shock; damaging a gas line can result in an explosion; penetrating a water pipe will cause property damage or an electrical shock)
- Do not use a saw blade which is cracked, deformed or dull

WHEN SANDING

- **Use the tool only for dry sanding** (penetration of water into the tool increases the risk of an electric shock)
- Do not touch the moving sanding sheet
- Do not continue to use worn, torn or heavily clogged sanding sheets
- When sanding metal, sparks are generated; do not use vacuum cleaner and keep other persons and combustible material from work area

BATTERIES

- **Only use the following batteries and chargers with this tool**
 - SKIL battery: BY5197E-03 BY5196E-03
 - SKIL charger: SC5358E-01 QC5360E-01 QC5359E-00
- Do not use the battery when damaged; it should be replaced
- Do not disassemble the battery
- Do not expose tool/battery to rain
- Permitted ambient temperature (tool/charger/battery):
 - when charging 4...40°C
 - during operation -20...+50°C
 - during storage -20...+50°C

EXPLANATION OF SYMBOLS ON TOOL/BATTERY

- ③ This tool accepts most commonly available multi-tool accessories, including existing OIS and Starlock basic accessories
- ④ Read the instruction manual before use
- ⑤ Do not dispose of electric tools and batteries together with household waste material

USE

- Charging battery
 - ! **read the safety warnings and instructions provided with the charger**
- Removing/installing the battery ⑥
- LED-light L ⑦
 - LED-light automatically lights on when activating the on/off switch
 - ! **when LED-light starts flashing, the battery protection is activated (see below)**
- Battery protection
 - The tool is suddenly being switched off or prevented from being switched on, when
 - **the load is too high**
 - **the battery temperature is not within the allowable operating temperature range of -20 to +50°C**
 - **the battery is nearly empty (to protect against deep discharge)**
 - ! **do not continue to press the on/off switch after the tool is switched off automatically; battery may be damaged**
- Changing accessories ⑧
 - ! **remove battery from tool**
 - remove/mount the required accessory as illustrated
 - ensure that the openings of the accessory engage into the tabs of the tool head (any snap-in position possible)
 - mount the accessory with the depressed centre pointing downwards
 - **check the tight seating of the accessory** (incorrect or not securely fastened accessories can come loose during operation and create a hazard)
- Dust suction ⑨
 - ! **remove battery from tool**
 - use vacuum cleaner adapter only when working with sanding pad
 - mount vacuum cleaner adapter as illustrated
 - connect vacuum cleaner
 - ! **do not use dust extraction device/vacuum cleaner when sanding metal**
 - clean vacuum cleaner adapter J regularly for optimal dust pick-up performance
- Mounting of sanding sheet ⑩
 - tap the dust out of the VELCRO material on sanding pad E before mounting the sanding sheet
 - mount VELCRO sanding sheet as illustrated
 - ! **the dust suction requires the use of perforated sanding sheets**
 - ! **perforation in sanding sheet should correspond with perforation in sanding foot**
 - ! **replace worn sanding sheets in time**
 - ! **always use the tool with the total VELCRO surface covered with sanding paper**
- On/off
 - switch on/off the tool by pushing switch in "I"/"O" position

- ! **before the accessory reaches the workpiece, the tool should run at full speed**
- ! **before switching off the tool, you should lift it from the workpiece**

- Adjusting working speed ⑪
 - with wheel the required oscillating frequency can be adjusted from low (1) to high (6) (also while tool is running)
 - the optimal working speed depends on the material and can be determined with practical trials
- Holding and guiding the tool
 - ! **while working, always hold the tool at the grey-coloured grip area(s) ⑫**
 - keep ventilation slots uncovered
 - do not apply too much pressure on the tool (excessive pressure will cause excessive heat and may shorten the service life of the accessory)
- Depth adjustment accessory (DEPTH STOP) ⑬

APPLICATION ADVICE

- For optimal results on different materials use table ⑭ as reference for determining the right accessory (accessories not standard included)

MAINTENANCE

- This tool is not intended for professional use
- Always keep tool clean (especially ventilation slots)
 - ! **remove battery from tool before cleaning**

ENVIRONMENT

- **Do not dispose of electric tools, batteries, accessories and packaging together with household waste material. The electric tools, accessories and packaging should be sorted for environmental-friendly recycling**
 - ! **prior to disposal protect battery terminals with heavy tape to prevent short-circuit**

WARRANTY

SKIL WARRANTY POLICY

For all SKIL warranty & enquiries, please contact 1300 01 SKIL (1300 01 7545) Monday to Friday 9:00am to 5:00pm EST

Chervon Australia Pty Ltd ABN 36 165 077 501 ("Chervon") warrants to the original domestic purchaser that this product will be free from defects in materials and workmanship for 5 years from date of purchase, and any battery or charger will be free from defects in materials and workmanship for 3 years from date of purchase. Consumables will be covered by a 3-month warranty and a complete list can be found inside the manual.

Notwithstanding the foregoing, if a SKIL consumer Power Tool is used for industrial, professional or commercial purposes, the foregoing warranty will apply for a duration of ninety days from the date of purchase. This ninety-day commercial warranty pertains to the SKIL Power Tool range only.

This SKIL product warranty is only applicable to purchases from authorised SKIL retailers. This warranty will not apply to SKIL products that are purchased from Amazon, eBay and any other non-authorised online retailer. This SKIL product warranty does not apply to any parallel imported product and does not apply to any SKIL products that are not purchased from an authorised SKIL retailer. To make a claim, return the faulty item together with proof of purchase directly to your closest service agent or to the place of purchase. Any handling and transportation costs (and other expenses incurred in claiming this warranty) are not covered by this warranty and will not be borne by Chervon. The replacement product or part or repaired product will be made available for your collection at an address nominated by Chervon. Where a valid warranty claim is made, Chervon will replace the defective product or repair the fault. Where the product is repaired, Chervon may use refurbished parts. This warranty does not cover normal wear and tear, misuse or abuse. This warranty may also be further limited or voided as specifically detailed in the product manual. Chervon has no other liability under this warranty. The benefits to you given by this warranty are in addition to other rights and remedies imposed by State and Federal legislation that cannot be excluded. Our goods come with guarantees that cannot be excluded under the Australian Consumer Law. You are entitled to a replacement or refund for a major failure and compensation for any other reasonably foreseeable loss or damage. You are also entitled to have the goods repaired or replaced if the goods fail to be of acceptable quality and the failure does not amount to a major failure. Chervon Australia Pty Ltd, Unit 14, 5 Kelletts Road, Rowville, VIC. 3178. Ph; 1300 01 SKIL (1300 01 7545). Email: support@skil.com.au

The following accessories and consumables have a 3-month warranty period:

Chucks	Allen keys
Brushes	Angle grinder flanges
Collets	Dust canisters



Industry leading battery technology wraps each cell with cooling material to keep the battery powering on for 25% longer run time compared to general battery technology.

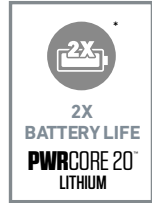

SKIL's patented technology extends the battery life 2X longer compared to general battery technology.

