

SKIL®

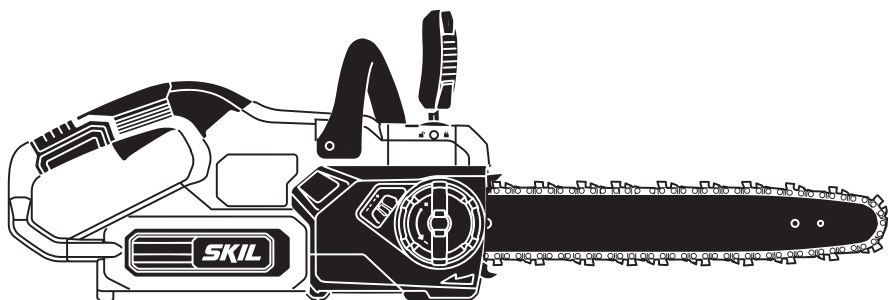

Model: CS4556E-00

PWRCORE 20™ **Brushless Chainsaw**

⚠ WARNING: To reduce the risk of injury, the user must read and understand the Owner's Manual before using this product. Save these instructions for future reference.



For Customer Service

1300-017-545 OR **www.skil.com.au**

1

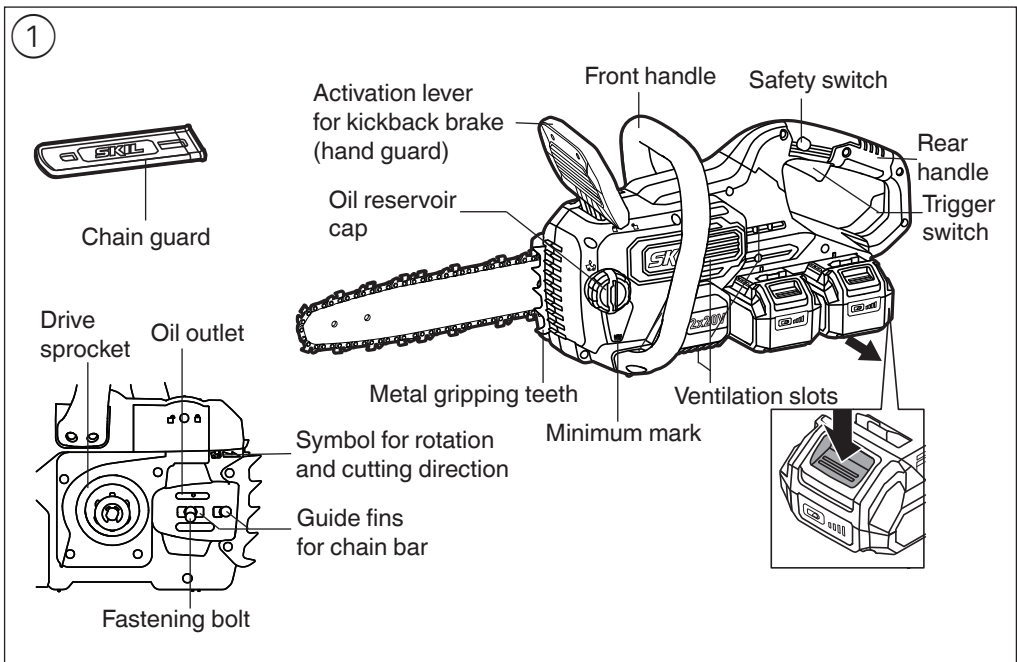

1

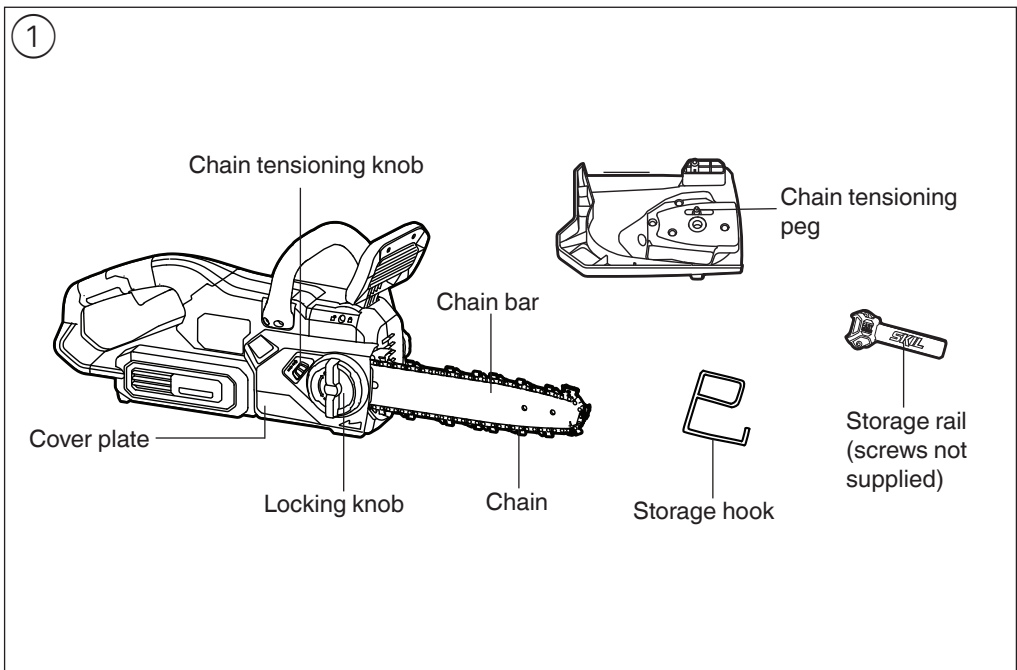

② SPECIFICATIONS

Rated Voltage	40V max d.c.
Weight	4.6 kg (with 2.5 Ah battery pack attached)
Weight	5.1 kg (with 5.0 Ah battery pack attached)
Chain Pitch	3/8" (9.5mm)
Chain Gauge	0.043" (1.1mm)
Replacement Chain	90PX052X
Replacement Chain Bar	144MLEA041
Guide Bar Length	14" (355mm)
Chain Speed	12m/s
Number of Drive Links	52

③



④



⑤



⑥



⑦



8

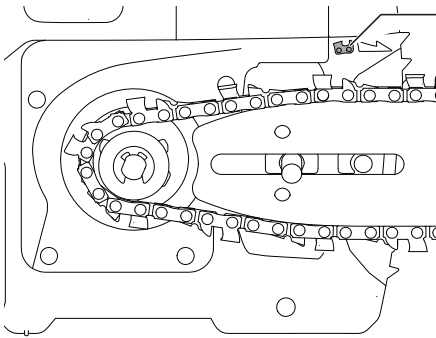
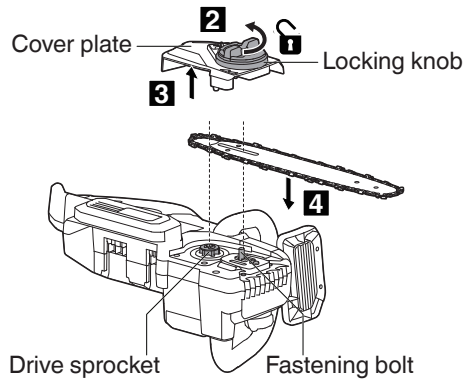
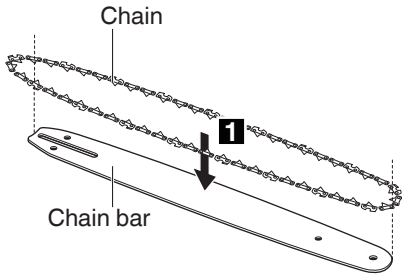

Symbol for rotation and cutting direction

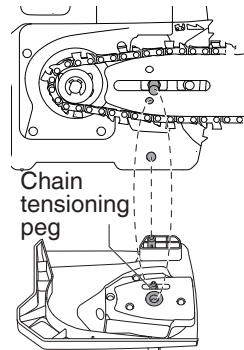
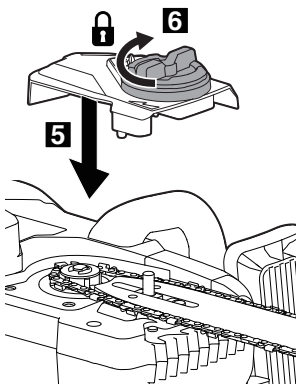
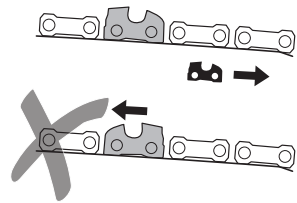

9

Battery level indicator

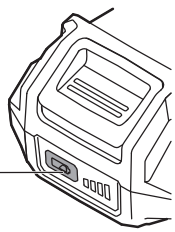

9 a

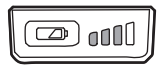

9 b

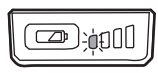

9 c



10

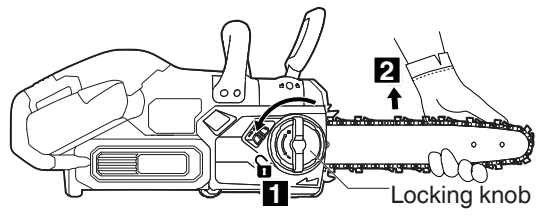

Locking knob

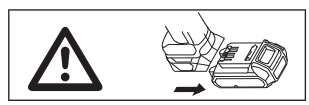

**! remove battery from tool
! always use gloves when
handling the chain**

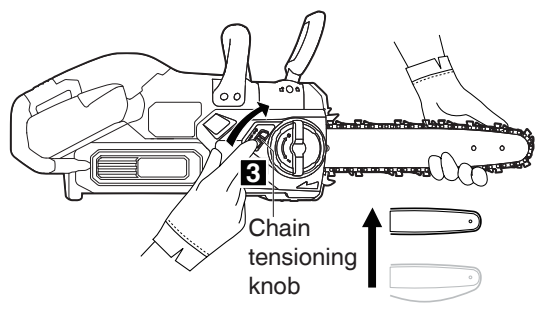

Chain tensioning knob

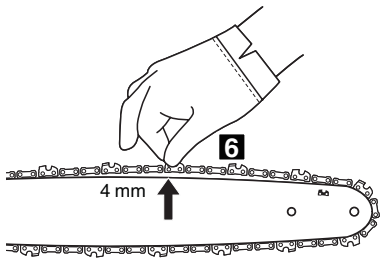
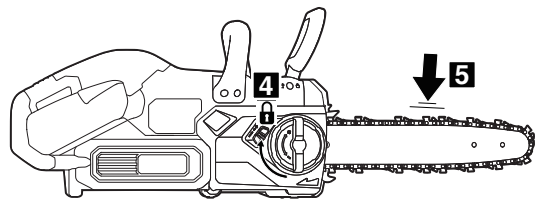

4 mm

11

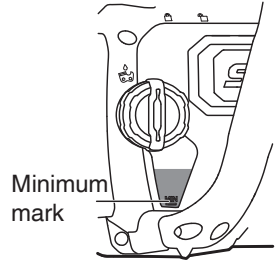
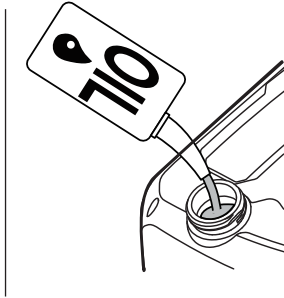
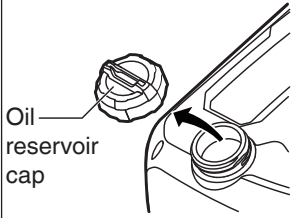

12

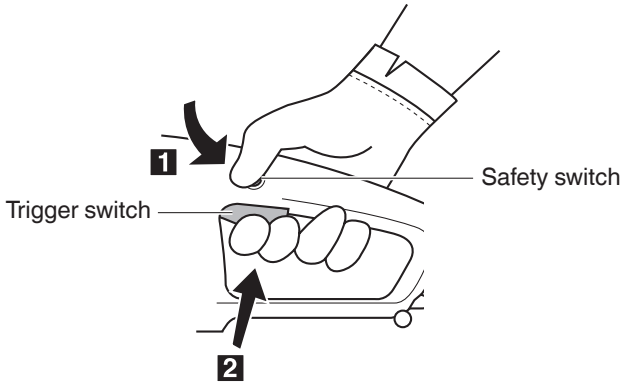

13 a

Activation lever for kickback brake (hand guard)

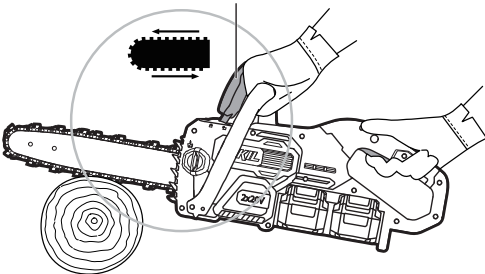

13 b

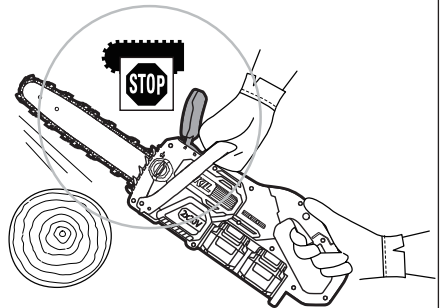

14 a

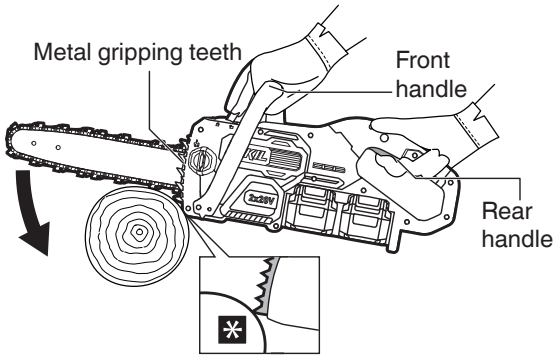

14 b

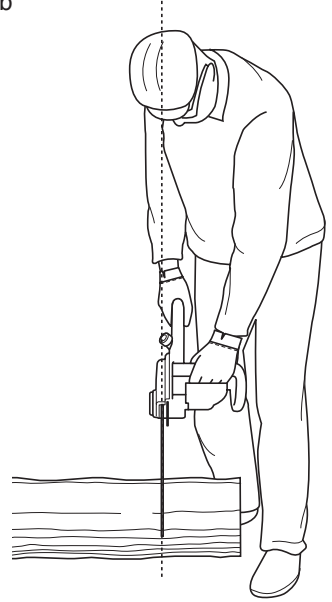

14 c

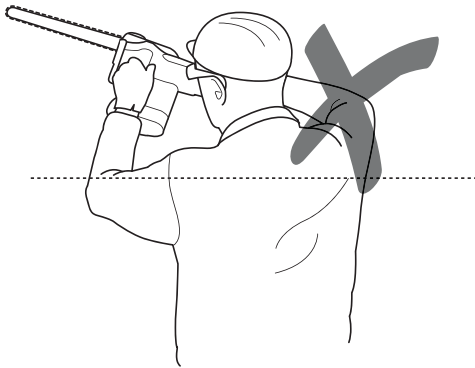

14 d



15 a

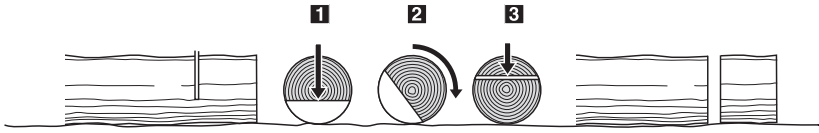

15 b

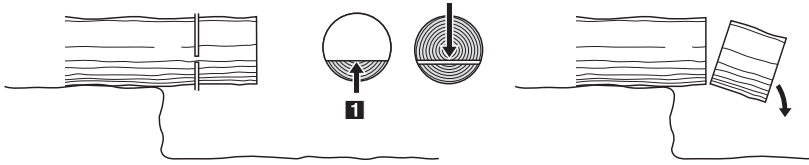

15 c

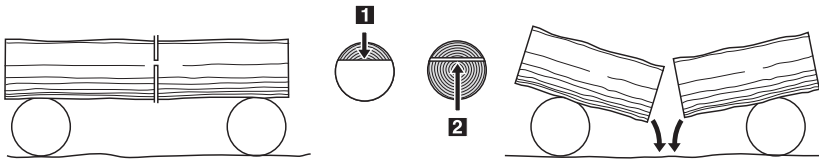

16 a

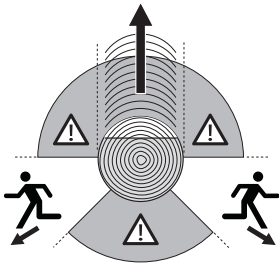

16 b

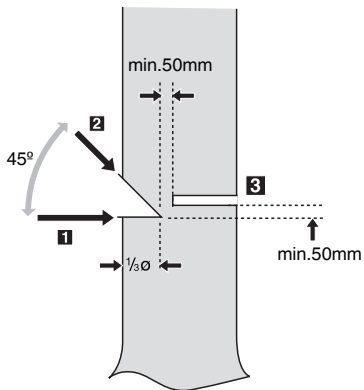

16 c

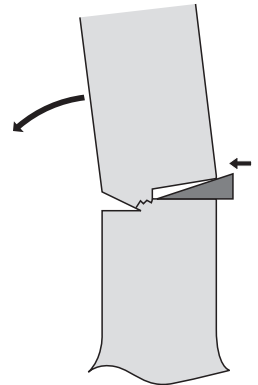

17

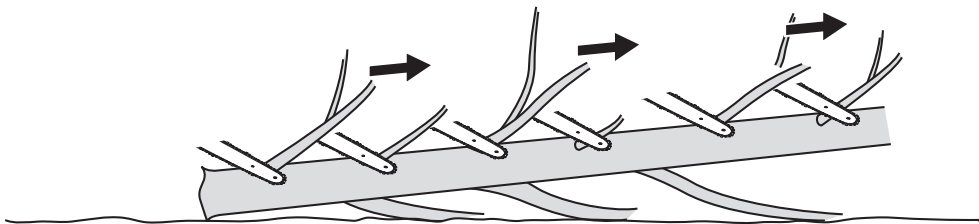

18

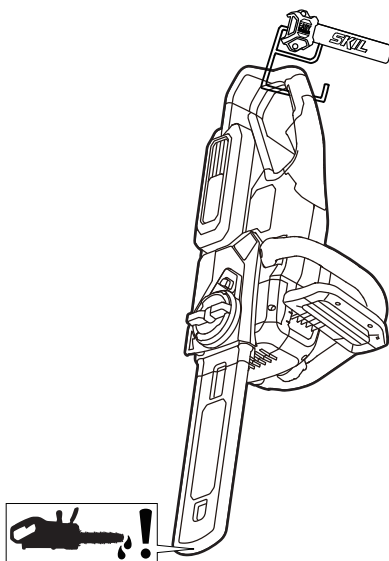
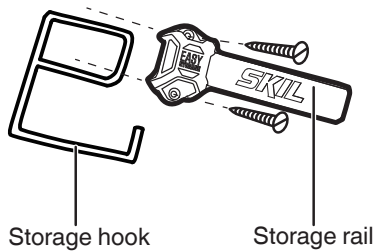

INTRODUCTION

- The power tool is intended for sawing wood such as wooden beams, planks, branches, tree trunks, etc., and for sawing of trees; cuts can be sawed with or across the grain
- This tool is not intended for professional use
- Check whether the packaging contains all parts as illustrated in drawing ①
- When parts are missing or damaged, please contact your dealer
- **Read and save this instruction manual ③**
- **Pay special attention to the safety instructions and warnings; failure to follow these may result in serious injury**

SAFETY

GENERAL POWER TOOL SAFETY WARNINGS

⚠ WARNING Read all safety warnings, instructions, illustrations and specifications provided with this power tool. Failure to follow all instructions listed below may result in electric shock, fire and/or serious injury.

Save all warnings and instructions for future reference.

The term "power tool" in the warnings refers to your mains-operated (corded) power tool or battery-operated (cordless) power tool.

1) WORK AREA SAFETY

- a) **Keep work area clean and well lit.** Cluttered or dark areas invite accidents.
- b) **Do not operate power tools in explosive atmospheres, such as in the presence of flammable liquids, gases or dust.** Power tools create sparks which may ignite the dust or fumes.
- c) **Keep children and bystanders away while operating a power tool.** Distractions can cause you to lose control.

2) ELECTRICAL SAFETY

- a) **Power tool plugs must match the outlet. Never modify the plug in any way. Do not use any adapter plugs with earthed (grounded) power tools.** Unmodified plugs and matching outlets will reduce risk of electric shock.
- b) **Avoid body contact with earthed or grounded surfaces such as pipes, radiators, ranges and refrigerators.** There is an increased risk of electric shock if your body is earthed or grounded.
- c) **Do not expose power tools to rain or wet conditions.** Water entering a power tool will increase the risk of electric shock.
- d) **Do not abuse the cord. Never use the cord for carrying, pulling or unplugging the power tool. Keep cord away from heat, oil, sharp edges or moving parts.** Damaged or entangled cords increase the risk of electric shock.
- e) **When operating a power tool outdoors, use an extension cord suitable for outdoor use.** Use of a cord suitable for outdoor use reduces the risk of electric shock.

- f) **If operating a power tool in a damp location is unavoidable, use a residual current device (RCD) protected supply.** Use of an RCD reduces the risk of electric shock.

3) PERSONAL SAFETY

- a) **Stay alert, watch what you are doing and use common sense when operating a power tool. Do not use a power tool while you are tired or under the influence of drugs, alcohol or medication.** A moment of inattention while operating power tools may result in serious personal injury.
- b) **Use personal protective equipment. Always wear eye protection.** Protective equipment such as a dust mask, non-skid safety shoes, hard hat, or hearing protection used for appropriate conditions will reduce personal injuries.
- c) **Prevent unintentional starting. Ensure the switch is in the off-position before connecting to power source and/or battery pack, picking up or carrying the tool.** Carrying power tools with your finger on the switch or energising power tools that have the switch on invites accidents.
- d) **Remove any adjusting key or wrench before turning the power tool on.** A wrench or a key left attached to a rotating part of the power tool may result in personal injury.
- e) **Do not overreach. Keep proper footing and balance at all times.** This enables better control of the power tool in unexpected situations.
- f) **Dress properly. Do not wear loose clothing or jewellery. Keep your hair and clothing away from moving parts.** Loose clothes, jewellery or long hair can be caught in moving parts.
- g) **If devices are provided for the connection of dust extraction and collection facilities, ensure these are connected and properly used.** Use of dust collection can reduce dust-related hazards.
- h) **Do not let familiarity gained from frequent use of tools allow you to become complacent and ignore tool safety principles.** A careless action can cause severe injury within a fraction of a second.

4) POWER TOOL USE AND CARE

- a) **Do not force the power tool. Use the correct power tool for your application.** The correct power tool will do the job better and safer at the rate for which it was designed.
- b) **Do not use the power tool if the switch does not turn it on and off.** Any power tool that cannot be controlled with the switch is dangerous and must be repaired.
- c) **Disconnect the plug from the power source and/or remove the battery pack, if detachable, from the power tool before making any adjustments, changing accessories, or storing power tools.** Such preventive safety measures reduce the risk of starting the power tool accidentally.
- d) **Store idle power tools out of the reach of children and do not allow persons unfamiliar with the power tool or these instructions to operate the power tool.** Power tools are dangerous in the hands of untrained users.

- e) **Maintain power tools and accessories. Check for misalignment or binding of moving parts, breakage of parts and any other condition that may affect the power tool's operation. If damaged, have the power tool repaired before use.** Many accidents are caused by poorly maintained power tools.
 - f) **Keep cutting tools sharp and clean.** Properly maintained cutting tools with sharp cutting edges are less likely to bind and are easier to control.
 - g) **Use the power tool, accessories and tool bits etc., in accordance with these instructions, taking into account the working conditions and the work to be performed.** Use of the power tool for operations different from those intended could result in a hazardous situation.
 - h) **Keep handles and grasping surfaces dry, clean and free from oil and grease.** Slippery handles and grasping surfaces do not allow for safe handling and control of the tool in unexpected situations.
- 5) BATTERY TOOL USE AND CARE**
- a) **Recharge only with the charger specified by the manufacturer.** A charger that is suitable for one type of battery pack may create a risk of fire when used with another battery pack.
 - b) **Use power tools only with specifically designated battery packs.** Use of any other battery packs may create a risk of injury and fire.
 - c) **When battery pack is not in use, keep it away from other metal objects like paper clips, coins, keys, nails, screws, or other small metal objects that can make a connection from one terminal to another.** Shorting the battery terminals together may cause burns or a fire.
 - d) **Under abusive conditions, liquid may be ejected from the battery; avoid contact. If contact accidentally occurs, flush with water. If liquid contacts eyes, additionally seek medical help.** Liquid ejected from the battery may cause irritation or burns.
 - e) **Do not use a battery pack or tool that is damaged or modified.** Damaged or modified batteries may exhibit unpredictable behaviour resulting in fire, explosion or risk of injury.
 - f) **Do not expose a battery pack or tool to fire or excessive temperature.** Exposure to fire or temperature above 130°C may cause explosion.
 - g) **Follow all charging instructions and do not charge the battery pack or tool outside the temperature range specified in the instructions.** Charging improperly or at temperatures outside the specified range may damage the battery and increase the risk of fire.
- 6) SERVICE**
- a) **Have your power tool serviced by a qualified repair person using only identical replacement parts.** This will ensure that the safety of the power tool is maintained.
 - b) **Never service damaged battery packs.** Service of battery packs should only be performed by the manufacturer or authorized service providers.

CHAIN SAW SAFETY WARNINGS

- **Keep all parts of the body away from the saw chain when the chain saw is operating. Before you start the chain saw, make sure the saw chain is not contacting anything.** A moment of inattention while operating chain saws may cause entanglement of your clothing or body with the saw chain.
- **Always hold the chain saw with your right hand on the rear handle and your left hand on the front handle.** Holding the chain saw with a reversed hand configuration increases the risk of personal injury and should never be done.
- **Hold the power tool by insulated gripping surfaces only, because the saw chain may contact hidden wiring.** Saw chains contacting a "live" wire may make exposed metal parts of the power tool "live" and could give the operator an electric shock.
- **Wear safety glasses and hearing protection. Further protective equipment for head, hand, legs and feet is recommended.** Adequate protective clothing will reduce personal injury by flying debris or accidental contact with the saw chain.
- **Do not operate a chain saw in a tree.** Operation of a chain saw while up in a tree may result in personal injury.
- **Always keep proper footing and operate the chain saw only when standing on fixed, secure and level surface.** Slippery or unstable surfaces such as ladders may cause a loss of balance or control of the chain saw.
- **When cutting a limb that is under tension be alert for spring back.** When the tension in the wood fibres is released the spring loaded limb may strike the operator and/or throw the chain saw out of control.
- **Use extreme caution when cutting brush and saplings.** The slender material may catch the saw chain and be whipped toward you or pull you off balance.
- **Carry the chain saw by the front handle with the chain saw switched off and away from your body. When transporting or storing the chain saw, always fit the guide bar cover.** Proper handling of the chain saw will reduce the likelihood of accidental contact with the moving saw chain.
- **Follow instructions for lubricating, chain tensioning and changing accessories.** Improperly tensioned or lubricated chain may either break or increase the chance for kickback.
- **Keep handles dry, clean, and free from oil and grease.** Greasy, oily handles are slippery causing loss of control.
- **Cut wood only. Don't use chain saw for purposes not intended (e.g. do not use chain saw for cutting plastic, masonry or non-wood building materials).** Use of the chain saw for operations different than intended could result in a hazardous situation.

CAUSES AND OPERATOR PREVENTION OF KICKBACK

- Kickback may occur when the nose or tip of the guide bar touches an object, or when the wood closes in and pinches the saw chain in the cut
- Tip contact in some cases may cause a sudden reverse reaction, kicking the guide bar up and back towards the operator
- Pinching the saw chain along the top of the guide bar may push the guide bar rapidly back towards the operator

- Either of these reactions may cause you to lose control of the saw which could result in serious personal injury (do not rely exclusively upon the safety devices built into your saw; as a chain saw user, you should take several steps to keep your cutting jobs free from accident or injury)
- Kickback is the result of tool misuse and/or incorrect operating procedures or conditions and can be avoided by taking proper precautions as given below:
 - **maintain a firm grip, with thumbs and fingers encircling the chain saw handles, with both hands on the saw and position your body and arm to allow you to resist kickback forces** (kickback forces can be controlled by the operator, if proper precautions are taken; do not let go of the chain saw)
 - **do not over reach and do not cut above shoulder height** (this helps prevent unintended tip contact and enables better control of the chain saw in unexpected situations)
 - **only use replacement bars and chains specified by the manufacturer** (incorrect replacement bars and chains may cause chain breakage and/or kickback)
 - **follow the manufacturer's sharpening and maintenance instructions for the saw chain** (decreasing the depth gauge height can lead to increased kickback)

PERSONAL SAFETY

- It is recommended that the first time user should have practical instruction in the use of the chain saw and the protective equipment from an experienced operator and that the initial practice should be cutting logs on a saw horse or cradle
- **Do not touch rotating chain**
- **Do not operate chain saw near other people, children or animals**
- **Do not operate chain saw after drinking alcohol or under the influence of intoxicating drugs or medication**
- Ensure that children do not play with the tool

AFTER USE

- Always switch off the tool and remove the battery
 - whenever leaving the tool unattended
 - before clearing jammed material
 - before checking, cleaning or working on the tool
 - after striking a foreign object
 - whenever the tool starts vibrating abnormally
- Store the tool **indoors** in a dry and locked-up place, out of reach of children
 - store the battery pack separately from the tool
- **Only use the following batteries and chargers with this tool**
 - SKIL battery: BY5197E-03 BY5196E-03
 - SKIL charger: SC5358E-01 QC5360E-01 QC5359E-00
- Do not use the battery when damaged; it should be replaced
- Do not disassemble the battery
- Do not expose tool/battery to rain
- Permitted ambient temperature (tool/charger/battery):
 - when charging 4...40°C
 - during operation -20...+50°C
 - during storage -20...+50°C

EXPLANATION OF SYMBOLS ON TOOL/BATTERY

- ③ Read the instruction manual before use
- ④ Do not expose tool to rain

- ⑤ Wear protective glasses and hearing protection
- ⑥ Do not dispose of electric tools and batteries together with household waste material
- ⑦ Guaranteed sound power level

USE

- Assembly instructions ⑧
 - ! **remove battery from tool**
 - ! **always use gloves when handling the chain**
 - place the chain saw on any suitable flat surface
 - remove cover plate by turning locking knob counter-clockwise
 - slide chain in the slot around chain bar
 - fit the chain onto drive sprocket and guide chain bar, so that fastening bolt and the guide fins fit into the keyway of chain bar
 - ! **ensure chain is in correct running direction by comparing with chain symbol**
 - check if all parts are seated properly and hold chain and chain bar in a level position
 - mount cover plate as illustrated
 - if necessary, turn tensioning knob to bring tensioning peg in alignment with the hole in chain bar
 - turn tensioning knob until all the slack is taken up in the chain
 - tighten locking knob on fastening bolt by turning it clockwise
- Charging battery
 - ! **read the safety warnings and instructions provided with the charger**
- Removing/installing the battery ①
 - 2 battery packs need to be installed
- Battery protection

The tool is suddenly being switched off or prevented from being switched on, when

 - **the load is too high** --> remove load and restart
 - **the battery temperature is not within the allowable operating temperature range of -20 to +50°C** --> 2 levels of the battery level indicator start flashing when pressing button ⑨b; wait until battery has returned within the allowable operating temperature range
 - **the battery is nearly empty (to protect against deep discharge)** --> a low battery level or flashing low battery level ⑨c is shown by the battery level indicator when pressing button; charge battery

! **do not continue to press the on/off switch after the tool is switched off automatically; battery may be damaged**
- Tensioning chain ⑩
 - ! **remove battery from tool**
 - place the chain saw on any suitable flat surface
 - check if the chain links are correctly located in the slot around chain bar
 1. loosen locking knob until it is just holding chain bar in position (**do not remove**)
 2. lift the chain bar somewhat and hold it in that position
 3. turn chain tensioning knob upwards until the lowest chain links come up and **JUST touch the bottom of chain bar**

4. tighten locking knob by turning it clockwise
 5. release chain bar
 6. the correct chain tension is reached when the chain can be raised approx. 4 mm from the chain bar in the centre
- ! always check the chain tension before use, after the first cuts and regularly during use (approx. every 10 minutes)**
- upon initial operation, new chains can lengthen considerably
 - the chain life of the saw chain mainly depends upon sufficient lubrication and correct tensioning
 - avoid tensioning the chain if it is hot, as this will cause the chain to become overtensioned when it cools down
- Lubrication ⑪
- Chain life and cutting capacity depend on optimum lubrication; therefore the chain is automatically oiled during operation via oil outlet ①
- ! the chain saw is not supplied filled with oil; it is essential to fill with oil before use**
- ! never operate the chain saw without chain oil or at an empty oil reservoir level, as this will result in extensive damage to the product**
- set chain saw on any suitable surface with oil reservoir cap facing upward
 - unscrew cap and add chain saw oil (not included) until reservoir is full
 - avoid dirt or debris entering oil reservoir
 - mount oil reservoir cap and tighten
- ! check oil level prior to starting and regularly during operation; refill oil when oil level is below indicator**
- the oil reservoir filling will last approx. 15 minutes, depending on sawing intensity and stops
 - never use recycled/old oil
- On/off ⑫
- switch on tool by first pressing safety switch and then pulling trigger switch
 - switch off the tool by releasing trigger
- ! do not stop chain saw after sawing by activating front hand guard ① (= kickback brake)**
- Kickback brake ⑬
- The kickback brake is a safety mechanism activated through front hand guard, when kickback occurs -> chain stops immediately
- The following function check should be carried out at regular intervals:
- push front hand guard forward and start the chain saw -> the chain must not start
 - to deactivate the kickback brake, release trigger switch and pull hand guard backwards
- Operating the tool
- always hold the chain saw firmly with both hands (front handle with the left hand and rear handle with the right hand); never operate chain saw using only one hand ⑭a
 - ensure power cord is located to the rear, away from the chain and wood and so positioned that it will not be caught on branches or the like during cutting
- ! the chain must be running at full speed before it makes contact with the wood**
- use metal gripping teeth to secure the saw onto the wood before starting to cut ⑭a
 - use the gripping teeth as a leverage point (★) while cutting ⑭a
 - reset the gripping teeth at a lower point when sawing thicker logs by pulling the chain saw slightly backwards until the gripping teeth release, and reposition at a lower level to continue sawing; do not remove the saw completely from the wood
 - do not force the chain while cutting; let the chain do the work, using gripping teeth to apply minimum leverage pressure
 - use the chain saw only with secure footing
 - hold the chain saw at the right-hand side of your body ⑭b
 - do not operate the chain saw with arms fully extended or attempt to saw areas which are difficult to reach, or on a ladder ⑭c
 - never use the chain saw above shoulder height ⑭d
 - sawing is optimized when the chain speed remains steady during cutting
- ! beware when reaching the end of the cut; the weight of the saw may change unexpectedly as it cuts free from the wood (accidents may occur to legs and feet)**
- ! always remove the saw from a wood cut while the saw is running**
- Cutting logs
- support logs so that the face sides at the cut do not close in against each other, which would result in the chain being jammed or pinched
 - position and set short logs safely prior to sawing
 - when sawing, always take care to avoid hitting stones, nails, etc., as these could be thrown up or cause damage to the chain or serious injury to the operator or bystanders
- ! keep a running chain clear of wire fencing or the ground**
- length cuts must be carried out with care, as leverage with gripping teeth ① is not possible; saw at a flat angle to avoid kickback
 - there is a high risk of accidents when sawing wood, branch or trees under tension; be extremely careful (**leave saw jobs like these to professionals!**)
- Bucking a log (cutting a log into lengths)
- when possible, the log should be raised and supported by the use of limbs, logs or chocks
 - it is important to make sure your footing is firm and your weight is evenly distributed on both feet
 - when the log is supported along its entire length as illustrated, it is cut from the top (overbuck) ⑮a
 - when the log is supported on one end as illustrated, cut 1/3 the diameter from the underside (underbuck); then make the finished cut by overbuckling to meet the first cut ⑮b
 - when the log is supported on both ends as illustrated, cut 1/3 the diameter from the top (overbuck); then make the finished cut by underbuckling the lower 2/3 to meet the first cut ⑮c
 - when bucking on a slope always stand on the uphill side of the log
 - when "cutting through", to maintain complete control release the cutting pressure near the end of the cut without relaxing your grip on the chain saw handles

! do not let the chain contact the ground

- after completing the cut, wait for the saw chain to stop before you move the chain saw
- always stop the motor before moving from tree to tree

• Felling trees 16

! the chain saw can only be used to fell trees smaller in diameter than the length of the chain bar

! secure work area; ensure no persons or animals are in the vicinity of the falling tree

! never attempt to free a jammed saw with the motor running; use wooden wedges to free chain and chain bar

! always wear hard hat to protect head against falling branches

BEFORE FELLING:

- when cutting and felling operations are being performed by two or more persons at the same time, the felling operations should be separated from the cutting operation by a distance of at least twice the height of the tree being felled
- trees should not be felled in a manner that would endanger any person, strike any utility line or cause any property damage (if the tree does make contact with any utility line, the company should be notified immediately)
- the chain saw operator should keep on the uphill side of the terrain as the tree is likely to roll or slide downhill after it is felled
- an escape path should be planned and cleared as necessary before cuts are started (the escape path should extend back and diagonally to the rear of the expected line of fall) 16a
- before felling is started, consider the natural lean of the tree, the location of larger branches and the wind direction to judge which way the tree will fall
- remove dirt, stones, loose bark, nails, staples and wire from the tree

FELLING PROCEDURE:

- make the notch (1 – 2) 1/3 the diameter of the tree, perpendicular to the direction of falls as illustrated 16b
- make the lower horizontal notching cut first (this will help to avoid pinching either the saw chain or the guide bar when the second notch is being made)
- make the felling back cut (3) at least 50 mm higher than the horizontal notching cut (keep the felling back cut parallel to the horizontal notching cut) 16b
- make the felling back cut so enough wood is left to act as a hinge (the hinge wood keeps the tree from twisting and falling in the wrong direction; do not cut through the hinge)
- as the felling gets close to the hinge the tree should begin to fall
- if there is any chance that the tree may not fall in desired direction or it may rock back and bind the saw chain, stop cutting before the felling back cut is complete and use wedges of wood, plastic or aluminium to open the cut and drop the tree along the desired line of fall 16c
- when the tree begins to fall remove the chain saw from the cut, stop the motor, put the chain saw down, then use the retreat path planned (be alert for overhead limbs falling and watch your footing)

• Limbing a tree 17

- Limbing is removing the branches from a fallen tree
- when limbing leave larger lower limbs to support the log off the ground
 - remove the small limbs in one cut as illustrated
 - branches under tension should be cut from the bottom up to avoid binding the chain saw

MAINTENANCE / SERVICE

- This tool is not intended for professional use
- Always keep tool clean (especially ventilation slots 1)
 - ! remove battery from tool before cleaning**
 - clean the moulded plastic housing of the chain saw using a soft brush and clean cloth (do not use water, solvents or polishes)
 - remove and brush clean the cover plate, chain and chain bar after 1 to 3 hours of use
 - clean the area under cover plate, drive sprocket and chain bar assembly using a soft brush and clean cloth
 - clean oil outlet with a clean cloth
- Regularly check for obvious defects such as loose, dislodged or damaged chain and chain bar, loose fixings, and worn or damaged components
- Carry out necessary maintenance and repairs before using the chain saw
- Proper functioning of the automatic oiler can be checked by running the chain saw and pointing the tip of the chain bar towards a piece of cardboard or paper on the ground
 - ! do not touch the ground with the chain (ensure safety clearance of 20 cm)**
 - if an increasing oil pattern develops, the automatic oiler is operating fine
 - if there is no oil pattern, despite a full oil reservoir, see “TROUBLESHOOTING” or contact your dealer
- IStorage 18
 - if the chain saw is to be stored for a longer period of time, clean chain and chain bar
 - when storing tool, the oil reservoir must be completely emptied
 - use chain guard when storing the tool
 - securely mount storage rail Y on the wall with 2 screws (**not supplied**) and horizontally leveled
 - make sure that hook is mounted together with rail
 - store the tool by hanging it on the storage hook
 - be aware of oil leakage when using storage hook
 - store the tool **indoors** in a dry and locked-up place, out of reach of children

TROUBLESHOOTING

- The following listing shows problem symptoms, possible causes and corrective actions (if these do not identify and correct the problem, contact your dealer or service station)
 - ! in case of electrical or mechanical malfunction, immediately switch off the tool and remove battery**
- ★ Tool does not operate
 - kickback brake is activated -> pull hand guard 1 back in position
 - empty battery -> charge battery
 - hot battery -> let battery cool down
 - internal fault -> contact dealer/service station

- ★ Tool operates intermittently
 - internal wiring defective -> contact dealer/service station
 - on/off switch defective -> contact dealer/service station
- ★ Dry chain
 - no oil in reservoir -> refill oil
 - vent in oil reservoir cap clogged -> clean cap
 - oil passage clogged -> clean oil passage outlet
- ★ Brake does not stop chain
 - kickback brake/run-down brake defective -> contact dealer/service station
- ★ Chain/chain bar overheats
 - no oil in reservoir -> refill oil
 - vent in oil reservoir cap clogged -> clean cap
 - oil passage clogged -> clean oil passage outlet
 - chain is overtensioned -> adjust chain tension
 - dull chain -> sharpen chain or replace
- ★ Tool vibrates abnormally
 - chain tension too loose -> adjust chain tension
 - dull chain -> sharpen chain or replace
 - chain worn out -> replace chain
 - chain teeth are facing in the wrong direction -> reassemble with chain in correct direction

ENVIRONMENT

- **Do not dispose of electric tools, batteries, accessories and packaging together with household waste material.** The electric tools, accessories and packaging should be sorted for environmental-friendly recycling
! prior to disposal protect battery terminals with heavy tape to prevent short-circuit

WARRANTY

SKIL WARRANTY POLICY

For all SKIL warranty & enquiries, please contact 1300 01 SKIL (1300 01 7545) Monday to Friday 9:00am to 5:00pm EST

Chervon Australia Pty Ltd ABN 36 165 077 501 (“Chervon”) warrants to the original domestic purchaser that this product will be free from defects in materials and workmanship for 5 years from date of purchase, and any battery or charger will be free from defects in materials and workmanship for 3 years from date of purchase. Consumables will be covered by a 3-month warranty and a complete list can be found inside the manual.

Notwithstanding the foregoing, if a SKIL consumer Power Tool is used for industrial, professional or commercial purposes, the foregoing warranty will apply for a duration of ninety days from the date of purchase. This ninety-day commercial warranty pertains to the SKIL Power Tool range only.

This SKIL product warranty is only applicable to purchases from authorised SKIL retailers. This warranty will not apply to SKIL products that are purchased from Amazon, eBay and any other non-authorised online retailer. This SKIL product warranty does not apply to any parallel imported product and does not apply to any SKIL products that are not purchased from an authorised SKIL retailer. To make a claim, return the faulty item together with proof of purchase directly to your closest service agent or to the place of purchase. Any handling and transportation costs (and other expenses incurred in claiming this warranty) are not covered by this warranty and will not be borne by Chervon. The replacement product or part or repaired product will be made available for your collection at an address nominated by Chervon. Where a valid warranty claim is made, Chervon will replace the defective product or repair the fault. Where the product is repaired, Chervon may use refurbished parts. This warranty does not cover normal wear and tear, misuse or abuse. This warranty may also be further limited or voided as specifically detailed in the product manual. Chervon has no other liability under this warranty. The benefits to you given by this warranty are in addition to other rights and remedies imposed by State and Federal legislation that cannot be excluded. Our goods come with guarantees that cannot be excluded under the Australian Consumer Law. You are entitled to a replacement or refund for a major failure and compensation for any other reasonably foreseeable loss or damage. You are also entitled to have the goods repaired or replaced if the goods fail to be of acceptable quality and the failure does not amount to a major failure. Chervon Australia Pty Ltd, Unit 14, 5 Kelletts Road, Rowville, VIC. 3178.
Ph; 1300 01 SKIL (1300 01 7545).
Email: support@skil.com.au

The following accessories and consumables have a 3-month warranty period:

Chucks	Allen keys
Brushes	Angle grinder flanges
Collets	Dust canisters

*



Industry leading battery technology wraps each cell with cooling material to keep the battery powering on for 25% longer run time compare to general battery technology.

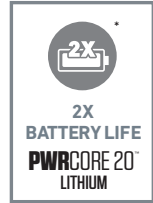

SKIL's patented technology extends the battery life 2X longer compare to general battery technology.